



DEFINITY®

**CALLMASTER® II and
CALLMASTER® III Voice Terminals
User and Installation Instructions**

AT&T 555-015-168
COMCODE 107319659
Issue 1, August 1994

WARRANTY

All terms and conditions specified in your agreement with AT&T apply.

NOTICE

While reasonable efforts were made to ensure that the information in this document was complete and accurate at the time of printing, AT&T can assume no responsibility for any errors. Changes or corrections to the information contained in this document may be incorporated into future issues.

TO ORDER COPIES OF THIS DOCUMENT

Contact: AT&T Customer Information Center
2855 North Franklin Road
P.O. Box 19901
Indianapolis, Indiana 46219
1-800-432-6600,
In Canada: 1 800-255-1242

Order: Document No. 555-015-168
Issue 1, August 1994

For more information about AT&T documents, see *Business Communications Systems Publications Catalog* (555-000-010).

Prepared by
AT&T GBCS Documentation Development
Middletown, New Jersey 07748

©1994 AT&T
All Rights Reserved
Printed in USA

HEARING AID COMPATIBILITY

This terminal is compatible with inductively coupled hearing aids as prescribed by the Federal Communications Commission.

INTERFERENCE WARNING INFORMATION - Part 15 of FCC Rules

Federal Communications Commission (FCC) Rules require that you be notified of the following:

This equipment has been tested and found to comply with the limits for a Class A digital device, pursuant to Part 15 of the FCC Rules. These limits are designed to provide reasonable protection against harmful interference in a business installation. This equipment generates, uses, and can radiate radio frequency energy and, if not installed and used in accordance with the instructions, may cause harmful interference to radio communications. However, there is no guarantee that interference will not occur in a particular installation. If this equipment does cause interference to radio or television reception, which can be determined by turning the equipment off and on, the user is encouraged to try to correct the interference by one or more of the following measures:

- 1 Reorient or relocate the receiving antenna.
- 2 Increase the separation between the equipment and receiver.
- 3 Connect the equipment into an outlet on a circuit different from that to which the receiver is connected.
- 4 Consult the dealer or an experienced radio/TV technician for help.

You may find the following booklet, prepared by the Federal Communications Commission, helpful: *How to Identify and Resolve Radio-TV Interference Problems*. This booklet is available from the U.S. Government Printing Office, Washington, D.C. 20042, Stock No. 004-000-00345-4.

IMPORTANT SAFETY INSTRUCTIONS

Only the most careful attention has been devoted to quality standards in the manufacture of your new voice terminal. Safety is a major factor in the design of every set. But, safety is YOUR responsibility too.

Please carefully read the helpful tips listed below and on the next page. These suggestions will enable you to take the fullest advantage of your new voice terminal. Retain these tips for later use.

Use

When using your voice terminal, the following safety precautions should always be followed to reduce the risk of fire, electric shock, and injury to persons.

- Read and understand all instructions.
- Follow all warnings and instructions marked on the voice terminal.
- This voice terminal can be hazardous if immersed in water. If you accidentally drop the voice terminal into water, do not retrieve it until you have first unplugged the line cord from the modular wall jack. Do not reconnect the voice terminal until it has dried thoroughly.
- Avoid using the voice terminal during electrical storms in your immediate area. There is a remote risk of electric shock from lightning. Urgent calls should be brief. Even though protective measures may have been installed to limit electrical surges from entering your business, absolute protection from lightning is impossible.
- If you suspect a natural gas leak, report it immediately, but use a telephone away from the area in question. The telephone's electrical contacts could generate a tiny spark. While unlikely, it is possible that this spark could ignite heavy concentrations of gas.
- Never push objects of any kind into the voice terminal through housing slots since they may touch hazardous voltage points or short out parts that could result in a risk of electric shock. Never spill liquid of any kind on the voice terminal. If liquid is spilled, however, refer servicing to proper service personnel.
- To reduce the risk of electric shock, do not disassemble this voice terminal. There are no user-serviceable parts inside. Opening or removing covers may expose you to hazardous voltages. Incorrect reassembly can cause electric shock when the voice terminal is subsequently used. If your voice terminal does not work properly, contact a qualified AT&T service technician.

Service

- 1 Before cleaning, unplug the voice terminal from the modular wall jack. Do not use liquid cleaners or aerosol cleaners. Use a damp cloth for cleaning.
- 2 Unplug the voice terminal from the modular wall jack and refer servicing to qualified service personnel when these conditions exist:
 - If liquid has been spilled into the voice terminal
 - If the voice terminal has been exposed to rain or water
 - If the voice terminal does not operate normally by following the operating instructions, adjust only those controls described in these instructions. Do not attempt to adjust any other controls since doing so may result in damage to the voice terminal and will require extensive work by a qualified technician to restore the voice terminal to normal operation.
 - If the voice terminal has been dropped or the housing has been damaged
 - If you note a distinct change in the performance of the voice terminal

WARNING: When this product is located in a separate building from the telephone communications system, a line current protector MUST be installed at the entry/exit points of ALL buildings through which the line passes.

The following are the ONLY acceptable devices for use in this application:

- ***AT&T 4-type protectors***
- ***ITW LINX™ LP-type protectors***

CAUTION: This voice terminal is NOT for residential use. It is for business systems applications ONLY. Use in a residential environment could result in an electrical short circuit when the telephone wiring is set up to provide other applications, for example, for appliance control or power transformers. The AC power used in these applications may create a safety hazard by placing a direct short circuit across the telephone wiring.

SAVE THESE INSTRUCTIONS

When you see this warning symbol on the product, refer to the instructions booklet packed with the product for information before proceeding.

Contents

Your CALLMASTER® Voice Terminal	6
The Headset (or the Handset)	6
The Recorder Interface	7
Organization of This Guide.....	7
Conventions	8
Feature Descriptions	9
Installation	13
Checklist of Parts	13
Orderable Equipment	14
Installing the CALLMASTER Voice Terminals	15
Testing the Headset or Handset	20
Labeling and Installing the Button-Designation Strips.....	20
Feature Procedures	22
Going Off-Hook	22
Raising or Lowering Receive Volume	22
Disconnecting From Calls	23
Conference.....	24
Drop.....	25
Hold	25
Mute	26
Select Ring (and Ringer Volume)	26
Self-Test	27
Transfer	28
Technical Description	29

Your CALLMASTER Voice Terminal

The AT&T CALLMASTER® voice terminals referred to in this manual include the CALLMASTER II and the CALLMASTER III models. Both of these voice terminals have been specially designed for use with the Automatic Call Distribution (ACD) system and the many features of DEFINITY Generic 1, Generic 2, and Generic 3.

The CALLMASTER II and the CALLMASTER III are identical in appearance. Each has six buttons that can be used for either call appearances or features and 15 buttons that are administered exclusively for features. They also have a 2-line supertwist liquid crystal display for showing call-related information, and designated buttons for both the ACD Log In and Release features.

The CALLMASTER II has a built-in Recorder Interface which allows you to connect the voice terminal to a recording device so that you can record all voice interactions. The CALLMASTER III does NOT have a Recorder Interface. For easy identification of which model you are using, see the model number printed on a sticker on the bottom of each CALLMASTER voice terminal.

NOTE: The tape recorder used with CALLMASTER II voice terminal with Recorder Interface must be purchased by the user; it is not provided with the voice terminal.

For more information on using ACD features, see *DEFINITY Generic 1 and Generic 3 ACD Agent Instructions, 555-204-722*; *DEFINITY Generic 2 and System 85 ACD Agent Instructions, 555-104-713*; *DEFINITY Generic 1 and Generic 3 ACD Supervisor Instructions, 555-230-724*; and *DEFINITY Generic 2 and System 85 ACD Supervisor Instructions, 555-104-714*.

THE HEADSET (OR THE HANDSET)

Since the CALLMASTER voice terminal is most often used with a headset, each set has two headset jacks, one on each side of the housing, so that one or two headsets can easily be connected. The voice terminal is immediately off-hook when the headset is plugged into the voice terminal.

With the use of an optional handset D-Kit, a K-2G2 optional handset can be added to the voice terminal. (See "Orderable Equipment" in the **Installation** section of these instructions for Comcodes of the handset D-Kits and individual parts.) This kit includes a handset and handset cord, a PJ327 adapter so that the handset cord can be connected to one of the headset jacks, and a cradle in which the handset can be kept when it is not in use. (This cradle *cannot* be used as a switchhook).

If you have both a handset and a headset plugged into a CALLMASTER voice terminal, you may want to unplug the handset when you are not using it, since it can pick up nearby noises (such as papers being shuffled) which may be heard over the headset.

THE RECORDER INTERFACE

The CALLMASTER II with Recorder Interface is designed for recording calls on a standard analog tape recorder. [A recorder with AGC (Automatic Gain Control) is recommended.] With this interface, a warning tone, a soft beep repeated every 15 seconds, notifies the agent and the calling party that the call is being recorded. *Be aware that this tone may be a legal requirement.* To generate this warning tone while using the Service Observing feature to monitor calls, the ACD split supervisor must activate the listen/talk mode and remain in this mode while the call is being recorded.

Important: The use of service observing features and call recording features may be subject to federal, state, and local laws, rules, or regulations and may be prohibited pursuant to the laws, rules, or regulations or require the consent of one or both of the parties to the conversation. Customers should familiarize themselves with and comply with all applicable laws, rules, and regulations before using these features.

ORGANIZATION OF THIS GUIDE

This user's guide is divided into four main sections:

Feature Descriptions—Use the drawing to locate the features on your CALLMASTER voice terminal; use the feature descriptions and explanations to help you remember how these features are used.

Installation—Use the procedures listed in this section to install your CALLMASTER voice terminal. The procedures are the same for both the CALLMASTER II and CALLMASTER III.

Feature Procedures—Follow the procedures listed here to use the fixed features on your voice terminal, those features you can use immediately.

Technical Description—This short section contains the dimensions, power requirements, and environmental requirements for the CALLMASTER voice terminal.

CONVENTIONS

The following conventions are used in the procedures:

xxxxx

This box represents a call appearance button, which is used exclusively for placing or receiving calls. The button has a red appearance light and a green status light and is labeled with an extension number (shown as **xxxxx**).

Feature

Each of these boxes represents a button to which a feature has been assigned. The button is labeled with a feature name.

Feature Descriptions

Familiarize yourself with your CALLMASTER voice terminal and its many features by reviewing **Figure 1** below and the feature explanations on the following pages.

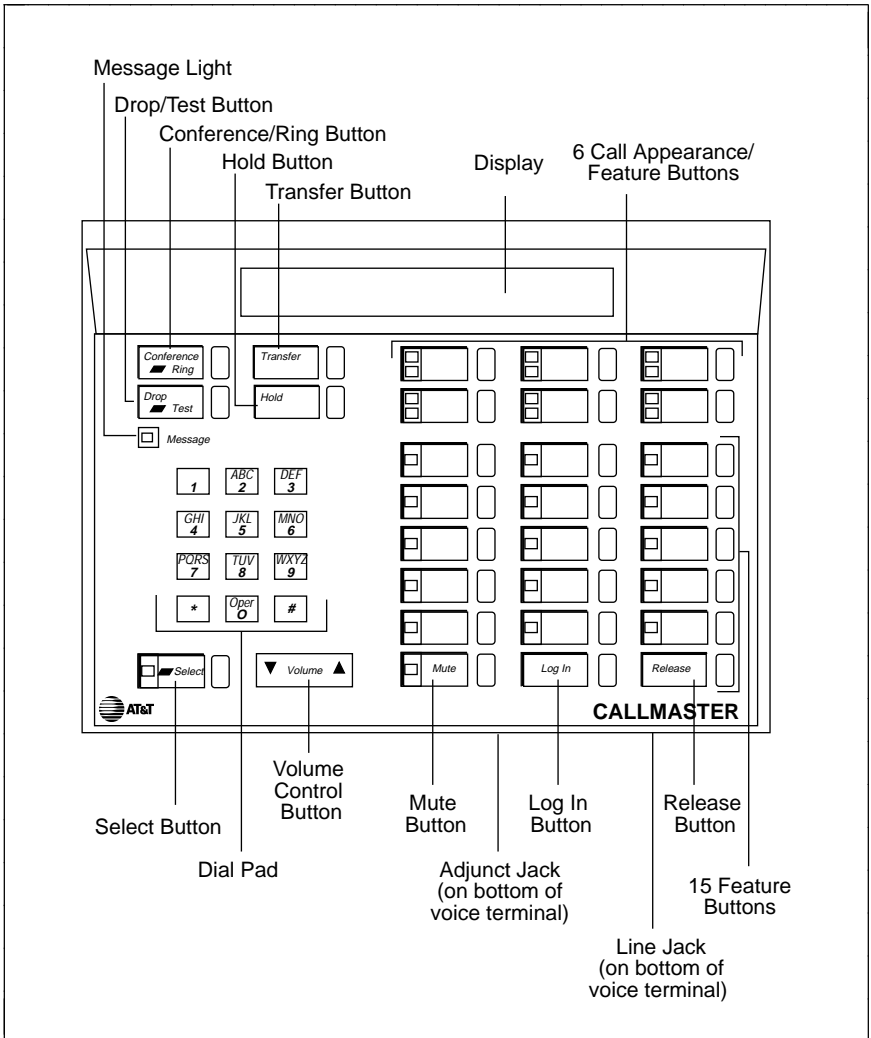

FIGURE 1 The CALLMASTER (II and III) Voice Terminal

Starting at the top left of **Figure 1** and continuing clockwise:

Message Light A red light which goes on steadily when a message has been left for you.

Drop/Test Button For disconnecting from a call or dropping the last party added to a conference call. When used with , you can perform a self-test of your voice terminal lights and tone ringer.

Conference/Ring Button For setting up conference calls. With a DEFINITY Generic 1 or Generic 3, the conference can include up to six parties. DEFINITY Generic 2 users can conference up to three parties. (To add more parties, DEFINITY Generic 2 users should see their system manager.) When used with , you can select a personalized ringing pattern for your voice terminal.

Hold Button A red button for putting calls on hold.

Transfer Button For transferring a call to another voice terminal.

Display A built-in supertwist LCD 2-line by 40-character display.

6 Call Appearance/Feature Buttons These six buttons are devoted to handling incoming and outgoing calls (**call appearances**) and are labeled with an extension number. Each button has a red appearance light beside it to tell you that this is the line you are using or that this is the line you will get when you answer a call. The green status light next to each call appearance and feature button tells you the line or feature is being used.

15 Feature Buttons Each of these 15 buttons accesses a feature and is labeled with a feature name. Each button has a green light beside it. When the green light goes on, the feature is active.

Release Button Use in ACD operation to end a call. However, pressing is equivalent to hanging up; you will not receive dial tone.

Line Jack (on bottom of voice terminal) This jack is used for connecting a line cord to your voice terminal. The jack is labeled "LINE."

Log in Button Use this button to automatically log in to the ACD system when you want to begin answering ACD calls.



Adjunct Jack (on bottom of voice terminal) This jack is used to connect compatible adjunct equipment, such as an S101A or S201A Speakerphone, a 507A Adapter, or a 500A Headset Adapter, to your voice terminal. The jack is labeled .

Mute Button For turning off the voice transmitter in the headset or handset so the other person cannot hear you.

Volume Control Button For adjusting the volume of the headset (or handset) when you are using the headset (or the handset) and a call is in progress, or for adjusting the volume of the tone ringer when you are not using the headset (or handset), and any time the voice terminal is ringing. You can also use the volume control to change ringer volume while you are selecting a personalized ring.

Dial Pad The standard 12-button pad for dialing phone numbers and accessing features. The letters, “Q” and “Z,” have been added to the appropriate dial pad keys for directory access, and the “5” button on your dial pad has raised bars for visually-impaired users.

Select Button Can be used in two different ways:

- 1) Used with  to initiate a self-test of your voice terminal;
- 2) Used with  to select your own personalized ring from among eight available patterns.

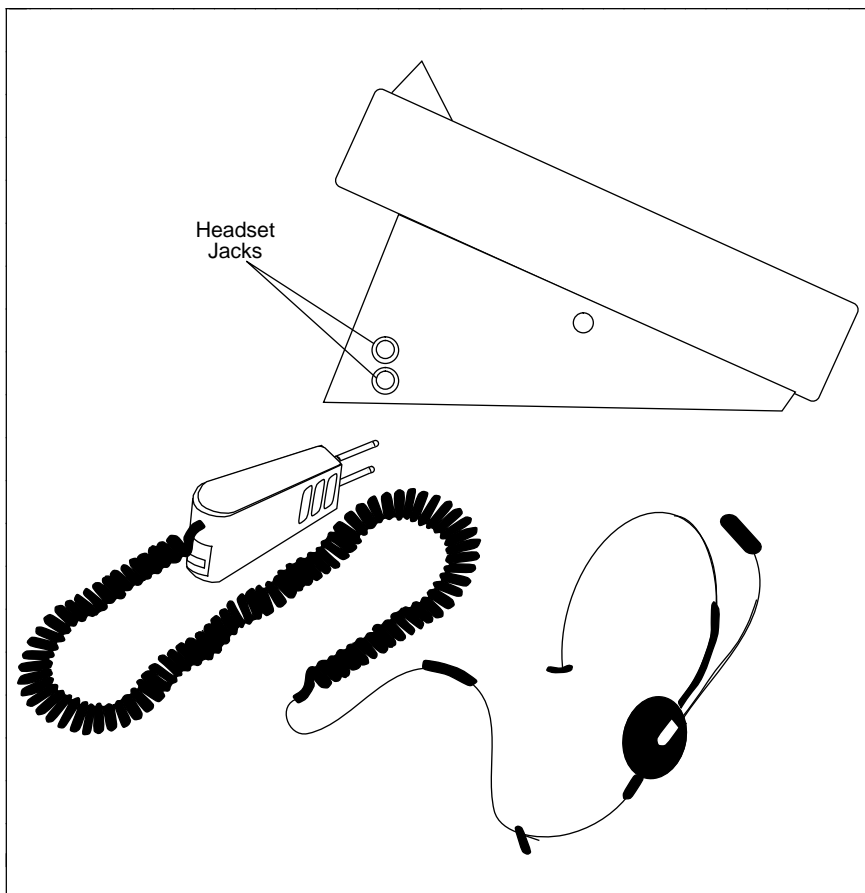

FIGURE 2 The headset jacks on the side of the CALLMASTER

On both **sides** of the CALLMASTER (II and III) voice terminals, as shown in **Figure 2** above, there is a set of headset jacks. Use these jacks for connecting a headset to your CALLMASTER set.

NOTE: Two headsets plugged into the sides of the CALLMASTER can be used simultaneously.

If any adjunct is active, the left and right headset jacks on the voice terminal are deactivated.

Installation

Use the following procedures to install your CALLMASTER voice terminal.

IMPORTANT: “DEFINITY CALLMASTER II and CALLMASTER III Instructions for Programming the Options,” 555-015-169, is a brief set of instructions which includes procedures for setting the display for 1 or 2 lines and for controlling the Mute button. For the CALLMASTER II, there are procedures for enabling or disabling the Recorder Interface, and the Recording Warning Tones. For the CALLMASTER III, there are procedures for setting the headset volume. It is important that **ONLY** a service technician or the system manager program these options. This document is orderable from the documentation center listed at the front of this book.

CHECKLIST OF PARTS

The CALLMASTER II and CALLMASTER III voice terminal package includes the following items:

- *Either* a CALLMASTER II Voice Terminal with Recorder Interface *or* a CALLMASTER III Voice Terminal without Recorder Interface (Both of these CALLMASTER voice terminal models come in black, misty cream, or white.)
- Line Cord (7-foot, 8-wire D8W87 modular cord)
- Button Designation Strips (silver strips to be used with the black CALLMASTER; international gray strips to be used with the misty cream and the white CALLMASTER)

ORDERABLE EQUIPMENT

The following equipment can be ordered by using the appropriate Comcode:

Orderable Equipment	
ITEM	COMCODE
CALLMASTER II Voice Terminal (with Recorder Interface)	
Black	106693294
Misty Cream	106693302
White	107316960
CALLMASTER III Voice Terminal (without Recorder Interface)	
Black	107316978
Misty Cream	107316994
White	107316986
Line Cord (7-foot, 8-wire D8W87 modular cord)	103786786
Line Cord (14-foot D8W modular cord)	103786802
Button Designation Strips, package of 25 (silver)	846753099
Button Designation Strips, package of 25 (international gray)	846953115
Button Designation Strips, package of 200 (silver)	846953107
Button Designation Strips, package of 200 (international gray)	846953123
Handset D-Kit #182083 (black)	105514798
Handset cradle *	845952944
Thumbscrew *	845952928
Handset K2G2 *	104030762
Handset cord H4DU *	102803327
PJ327 Adapter *	405730920
Handset D-Kit #182084 (misty cream)	105514806
Handset cradle *	845952951
Thumbscrew *	845952936
Handset K2G2 *	105489686
Handset cord H4DU *	104211305
PJ327 Adapter *	405730946

* This piece of equipment comes with the Handset D-Kit, but it can also be ordered separately with the Comcode in the second column.

Orderable Equipment (continued)	
ITEM	COMCODE
Handset D-Kit #182835 (white)	107318438
Handset cradle *	847278603
Thumbscrew *	847278611
Handset K2G2 *	107244352
Handset cord H4DU *	105635429
PJ327 Adapter *	407128354
Power module KS22911 L2	405331711
400B2 Adapter	104152558
Power cord (7-foot 2-pronged D6AP87 modular cord)	102937620

* This piece of equipment comes with the Handset D-Kit, but it can also be ordered separately with the Comcode in the second column.

INSTALLING THE CALLMASTER VOICE TERMINALS

Note: Use the following directions for installing *both* the CALLMASTER II and the CALLMASTER III voice terminals. The CALLMASTER voice terminal *cannot* be wall-mounted.

Connecting the Line and Optional Equipment Cords

See **Figure 3** for the location of the jacks mentioned below.

- 1 Lay the voice terminal face down so the bottom slopes toward you.
- 2 Plug the line cord into the line cord jack. Press firmly until you hear the line cord click.
- 3 Press the line cord into the line cord routing channel, placing the cord under the tab, and gently pull any slack from the cord to the rear of the voice terminal.
- 4 Turn the voice terminal rightside up so that the faceplate is facing you.
- 5 Plug the line cord into the modular wall jack. (Since the line cord is 7-feet long, your CALLMASTER voice terminal must be within this distance from the wall jack.)

NOTE: You may also use a 14-foot line cord. To order this cord, see “Orderable Equipment” earlier in these instructions.

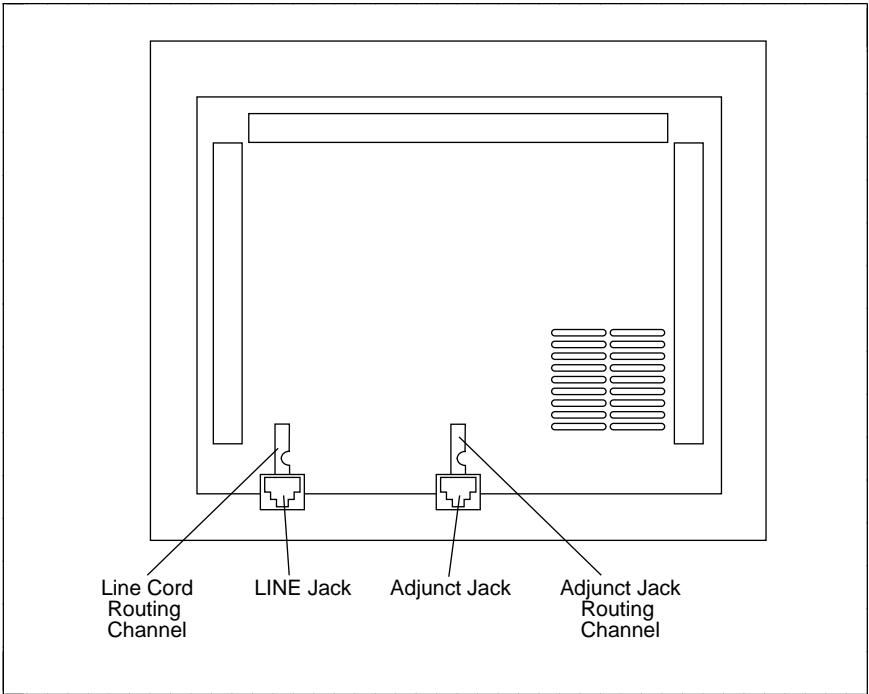

FIGURE 3 The LINE jack, adjunct jack, and routing channels

Important Notes on Installation

- ▶ The total distance between the CALLMASTER II voice terminal with Recorder Interface and the recording device should not exceed 200 feet.

- ▶ The distance between the CALLMASTER II or CALLMASTER III voice terminal and the PBX must NOT exceed the following:

In 4-wire mode, with 22-gauge or 24-gauge wire, the distance between the CALLMASTER II or CALLMASTER III and the PBX should not exceed 5,000 feet; with 26-gauge wire, the distance should not exceed 4,000 feet.

In 2-wire mode, which is applicable only to the CALLMASTER III, with 22-gauge wire, the distance between the CALLMASTER III and the PBX should not exceed 5,500 feet; with 24-gauge wire, the distance should not exceed 3,500 feet; with 26-gauge wire, the distance should not exceed 2,200 feet.

- ▶ The record output impedance is approximately 600 ohms and the output channel is isolated from the voice terminal with an FCC Part 68-approved voice transformer.

DCP Line Interface

The DCP line interface is a standard D8W 8-wire modular cord. One pair is used for balanced digital transmission *to* the PBX switch; another pair is used for balanced digital reception *from* the PBX switch. A third pair in the 8-wire modular cord provides auxiliary power for the adjunct, and a fourth pair is used only by the CALLMASTER II with Recorder Interface to provide the analog Record Out signals to an external tape recorder.

The 8 line-jack pins are numbered in increasing order from left to right when facing the jack with the tab slot down. The table below shows pin assignments for the line cord and jack block interface.

CONNECTOR BLOCK		DCP JACK INTERFACE		
Conn. Block Pin Number	D Inside Wire Color	Pin	Name	Signal Description
3	W-O	1	OD1	Balance output from telephone (power -48V)
4	O-W	2	OD2	Balance output from telephone (power -48V)
5	W-G	3	ID1	Balance input from PBX (power 0V)
1	W-BL	4	REC1	Record output from a CM II with Recorder Interface
			U-T*	On a CM III w/o Rec. Interface)
2	BL-W	5	REC2	Record output from a CM II with Recorder Interface
			U-R*	On a CM III w/o Rec. Interface)
6	G-W	6	ID2	Balance input from PBX (power 0V)
7	W-BR	7	P1-	Adjunct power -48V (to adjunct jack)
8	BR-W	8	P2+	Adjunct power common (to adjunct jack)

* U-T = "Tip"

U-R = "Ring"

Figure 4 shows how a CALLMASTER II with Recorder Interface should be configured through the wall jack with the DEFINITY PBX, an adjunct power source, and the recording device.

NOTE: Typically, a 104A wall jack is used in this type of configuration.

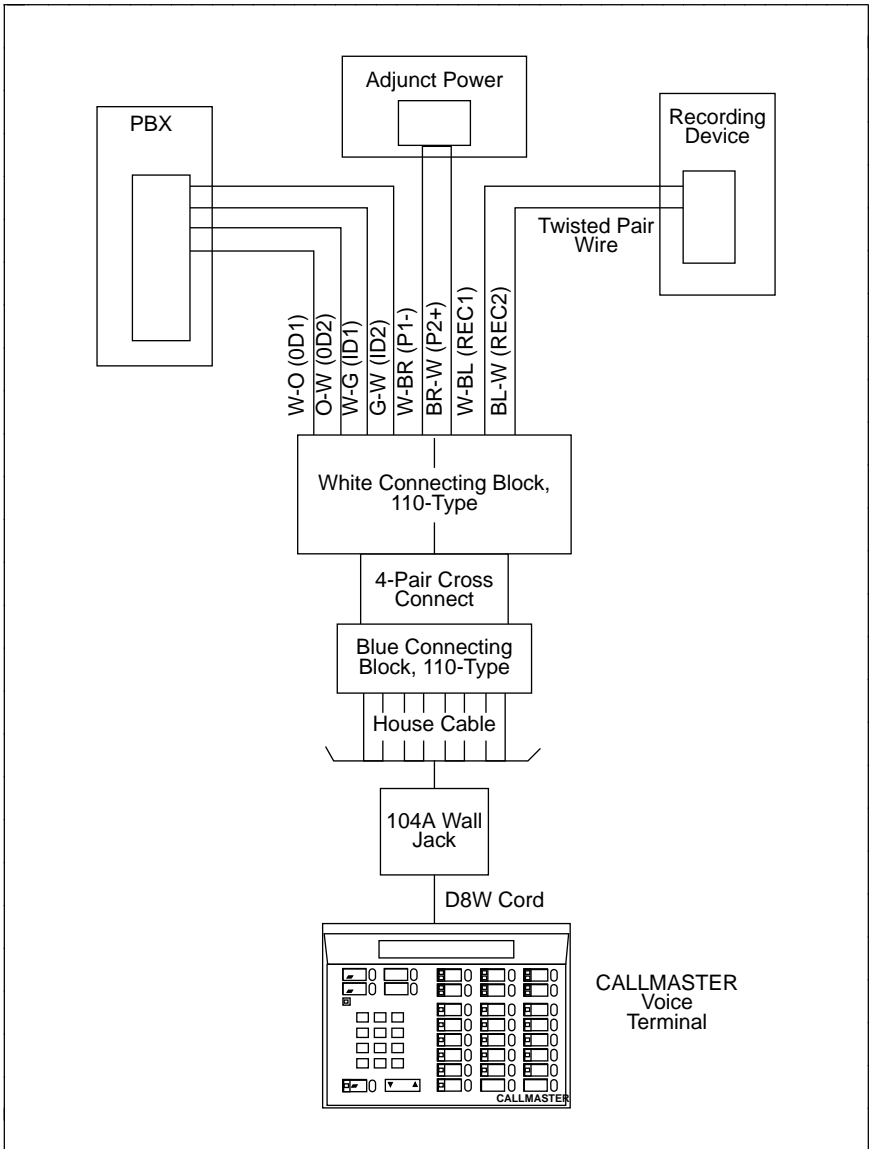

FIGURE 4 Connecting the CALLMASTER II with Recorder Interface to the PBX, adjunct power source, and the recording device

TESTING THE HEADSET OR HANDSET

- 1 If you are using a handset, use the installation instructions that come with the handset kit to install the handset cradle.
- 2 Plug in the headset or the handset, press a call appearance button, and listen for dial tone.
 - If you do not hear dial tone, press another call appearance button. You may also want to check that the cords are connected securely at both ends.

LABELING AND INSTALLING THE BUTTON-DESIGNATION STRIPS

- 1 Make sure that the voice terminal is right side up.
- 2 Type or write the numbers/features on the button designation strips with the appropriate button information.
- 3 Crease the perforated edges of the button designation strips and then tear out the button designation strips.
- 4 Install the strips by sliding them down into the correct button column slots, as shown in **Figure 5**.

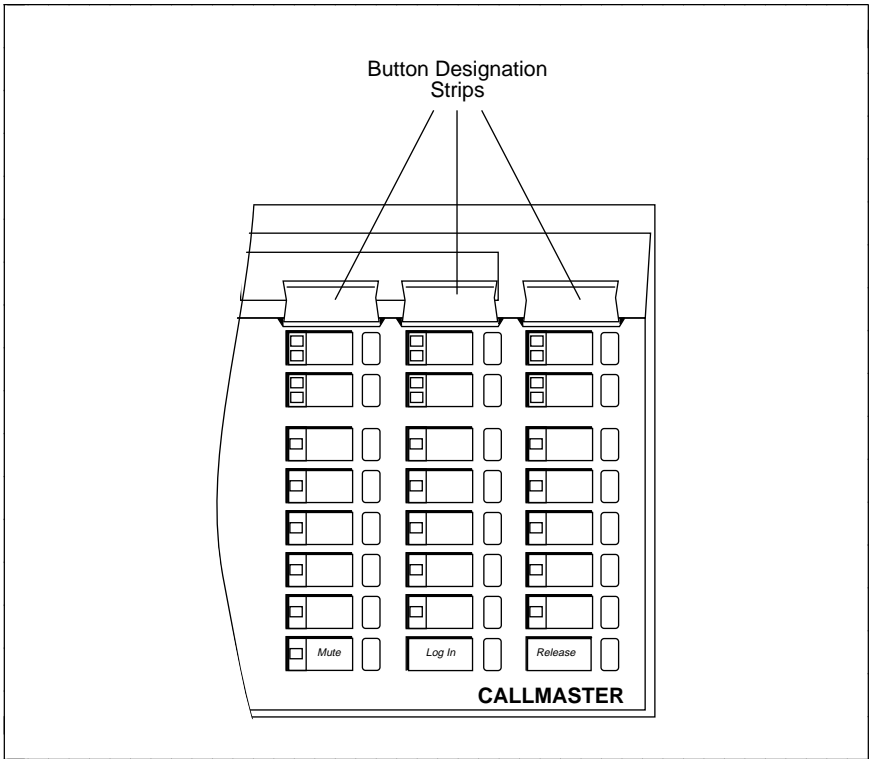

FIGURE 5 Inserting the designation strips

Feature Procedures

The following features can be used immediately. The procedures in this section give short, step-by-step instructions for using each of these features. For your convenience, beginning with the Conference feature, the features are listed alphabetically.

GOING OFF-HOOK



When the headset or handset is plugged into the terminal, it is immediately off-hook.

RAISING OR LOWERING RECEIVE VOLUME

You can use the Volume control button to raise and lower the receive level volume under the following conditions:

- The CALLMASTER voice terminal is off-hook, and the headset(s) is plugged in.
- The voice terminal is *not* off-hook on an external speakerphone call.
- No call is ringing.
- You are *not* in the midst of selecting a personalized ringing pattern.

To raise or lower the receive volume

- To raise the volume of the receive level of the headset or the handset, press the right half of the volume control button labeled  ;
- To lower the receive level of the headset or the handset, press the left half of the volume control button labeled  .

NOTE: There are eight possible volume settings. Each press of the volume control button raises or lowers the volume one incremental level.

As you raise or lower the headset volume level, the display reflects your choice, such as:

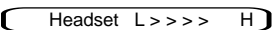

Headset L >>>> H

On the display, one arrow is the lowest setting, and eight arrows is the highest setting.

NOTE: For procedures to raise and lower the ringer volume on your CALLMASTER set, see the procedures for the Select Ring feature later in this section.

DISCONNECTING FROM CALLS

You can disconnect from a call in several ways:

- Press **Release** to disconnect from any type of call in approximately one-tenth of a second. This method is faster than waiting for a caller or trunk to disconnect and enables you to perform other ACD or voice terminal procedures sooner. You do not hear dial tone after you press **Release** .
- Press **Drop_{Test}** which disconnects you from a call and gives you dial tone. Use **Drop_{Test}** when you want to disconnect from an ACD or non-ACD call and place a call.

CONFERENCE

To add another party to an existing call

Note: If your CALLMASTER voice terminal is connected to a DEFINITY Generic 1 or Generic 3, the conference call can include up to six parties. If your CALLMASTER is connected to a DEFINITY Generic 2, the conference can include up to three parties. (For a conference call of more than three parties, contact your system manager.)

- 1 Press
 - Present call is put on hold; all other parties remain connected to each other
 - You are given a new call appearance and hear dial tone
- 2 Dial number of new party and wait for answer
 - If party answers, explain who is on the conference call and go on to Step 3
 - If party does not answer or if line is busy, press fluttering to return to held call (skip the next step)
- 3 Press again
 - All parties are now connected
 - Repeat Steps 1 through 3 to add another party to the conference call

To add a call you have put on hold to another call to which you are connected

- 1 Press
 - Green light at held call appearance continues to flutter
 - Green light at current call appearance also flutters
 - You are given a new call appearance and hear dial tone
- 2 Press of held call (first call)
- 3 Press again
 - All parties are now connected

DROP

To disconnect from an active 2-party call

1 Press

- You hear dial tone

NOTE: You may press instead of to disconnect faster. However, if you press you will not hear dial tone.

To drop the last party you added to a conference call

1 Press

- Last party added to conference call is dropped; you and other parties remain connected

HOLD

To put a call on hold while you answer another call, place a call, or perform some other task

1 Press

- Green light at held call appearance flutters

NOTE: If you put a conference call on hold, the other parties remain connected.

To answer a new call while active on another call

1 Press

- Green light at held call appearance flutters

2 Press of incoming call

To return to held call

1 Press of held call

MUTE

To prevent the other party from hearing you

- 1 Press **Mute**
 - Red light next to **Mute** goes on; other party cannot hear you
- 2 When you want to resume the conversation with the other party, press **Mute** again
 - Red light next to button goes off; caller can hear you again

NOTE: The Mute feature has no effect when an adjunct is active. Use the Mute feature on the adjunct equipment.

SELECT RING (AND RINGER VOLUME)

To select a personalized ring

NOTE: There are eight different ringing patterns from which to choose.

- 1 Press **Select**
 - Green light next to **Select** goes on steadily
- 2 Press **Conference Ring**
 - Green light next to **Select** winks
 - Current ring pattern plays and repeats every three seconds
 - Display shows the pattern you are currently hearing:
Personal Ring #x
("x" will be a number from 1 to 8)
- 3 Continue to press **Conference Ring** to cycle through all eight ring patterns
- 4 When you hear desired ring pattern, press **Select** again
 - Your new ring is set; light next to **Select** goes off



NOTE: If you receive a call, go off-hook, or lose power during selection, the process is interrupted and you must start again. If you lose power *after* you have selected your personalized ring, you will have to select your ringing pattern again.

Select Ring (and Ringer Volume) (Continued)

You can raise or lower the volume of the tone ringer under the following conditions:

- The CALLMASTER is on-hook, and the headset is unplugged
- The voice terminal is off-hook on the external speakerphone
- A call is ringing at the voice terminal
- You are in the process of selecting a personalized ringing pattern for your voice terminal.

To adjust ringer volume if necessary

- 1 To raise the volume, press the right half of the volume control button labeled  ;
to lower the volume, press the left half of the volume control button labeled  .





- Display shows the volume level:



(There are eight possible volume settings. On the display, one arrow indicates the lowest setting has been selected. Eight arrows indicates the highest setting has been selected.)

SELF-TEST

To test the lights and ringer of your voice terminal

- 1 While on-hook, press 
 - Green light next to  goes on
- 2 Press and hold 
 - Three groups of lights go on in sequence
 - Ringer sounds
 - Display is activated
- 3 Release  to end test
 - Ringer, display, and lights return to pretest state; light next to  goes off

TRANSFER

To send an existing call to another extension or outside number

- 1 Press
 - Green light at call appearance flutters
 - Present call is put on hold
 - You are given a new call appearance, and you hear dial tone
- 2 Dial number where call will be transferred
 - You hear ringback tone
 - If the call is answered, remain on line and announce call if desired
 - If not answered or if line is busy, return to held call by pressing where green light is fluttering
- 3 Press again
 - Call is transferred to dialed number

Technical Description

Physical Dimension and Weight

The CALLMASTER voice terminal can only be desk-mounted; it *cannot* be wall-mounted.

The CALLMASTER voice terminal measures

- 8.5 inches deep
- 11.0 inches wide
- 4.25 lbs

Power Requirements

The CALLMASTER voice terminal is line powered from the PBX switch. The CALLMASTER will operate in voltage ranges of 42.5 to 56.5 volts. See the **Installation** section for operating range requirements.

NOTE: If adjunct equipment such as an S201A Speakerphone is connected to the CALLMASTER voice terminal's Adjunct jack, it must be auxiliary powered.

Environmental Requirements

The CALLMASTER voice terminal can operate in temperatures ranging from 40 to 120 degrees F (4 to 48 degrees C) and relative humidity ranging from 5 to 95 percent.



Copyright © 1994 AT&T
All Rights Reserved